

Full Voltage Contactors

Definite Purpose Controls Advantages
(CR453C Compact).....4-2

Definite Purpose Controls Advantages
(CR453A Standard).....4-3

Compact, Single Phase, 20A-40A
(CR453C) Product Tables.....4-4

Compact, Single Phase, 20A-40A
(CR453C) Factory Modified Forms4-5

Standard, Single Phase, 25A-40A
(CR453A) Product Tables.....4-6

Standard, Single Phase, 25A-40A
(CR453A) Factory Modified Forms4-7

Standard, Three Phase, 4-pole, 25A-40A
(CR353) Product Tables.....4-8

Standard, Three Phase, 4-pole, 25A-40A
(CR353) Factory Modified Forms4-9

Standard, Three Phase, 2-pole and 3-pole, 50A-150A
(CR353) Product Tables4-10

Standard, Three Phase, 2-pole and 3-pole, 50A-150A
(CR353) Factory Modified Forms.....4-11

Standard, Three Phase and Single Phase, 25A-40A
(CR455) Product Tables4-12

Standard, 2-Speed Controllers, 25A-40A
(CR355) Product Tables4-13

Standard, Three Phase and Single Phase, 25A-40A
(CR455) Factory Modified Forms.....4-14

Full Voltage Starters

Standard, Three Phase and Single Phase, 3-Pole,
25A-40A (CR454) Product Tables.....4-15

Standard, Three Phase and Single Phase, 3-Pole,
25A-40A (CR454) Factory Modified Forms.....4-16

Standard, Three Phase and Single Phase, 2-Pole and
3-Pole, 50A-60A (CR354) Product Tables.....4-17

Standard, Three Phase and Single Phase, 2-Pole and
3-Pole, 50A-60A (CR354) Factory Modified Forms4-18

Heaters, Three Phase and Single Phase, 50A-60A4-19

Full Voltage Contactors and Starters

Accessories (CR453A, CR353).....4-20

Accessories (C-2000).....4-20

Replacement Coils and Renewal Parts,
Contactors and Starters.....4-22

Technical Data, Contactors and Starters.....4-24

Outlines and Dimensions, Contactors and Starters.....4-27

Bulk Pack Data.....4-34



Definite Purpose Controls Full Voltage Contactors

GE's New Definite Purpose Controls Deliver Definite Advantages

CR453C Compact

20A-40A

1-pole, 1-pole + shunt and 2-pole

Multiple terminal configurations on line and load terminals allow selection of the right terminals for the job. Choose from hex head screw terminals with slotted/Phillips head or box lug terminals, all with or without quick connect accessory terminals.

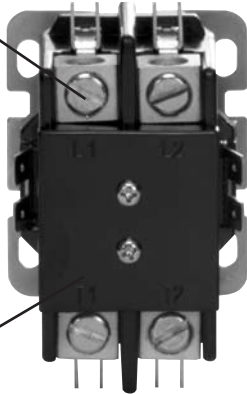

Cover (standard on 40A, optional on 25A-30A) offers increased protection from contaminants.

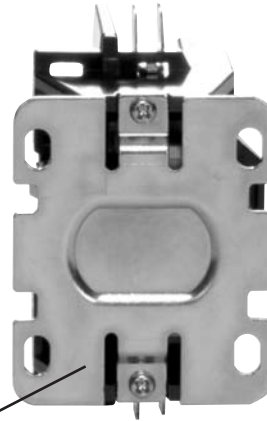

Universal mounting plate with multiple elongated holes allows the compact contactors to be used with the same mounting holes as existing designs—allowing easy replacement or simple substitution.

Wide array of coil voltages and frequencies allows the compact DP contactors to be adapted to a wide array of applications.

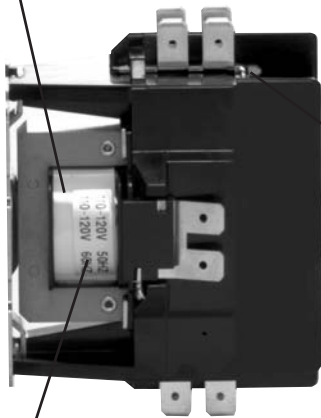

Large silver alloy contacts offer superior life and resistance to welding.

Low VA "no burn" coil design allows minimum CPT requirement and failsafe reliability during brownout conditions. Features standard 1/4" dual quick connect angled terminals for ease of wiring. Coils are tape wrapped for superior durability and protection from damage.

Outstanding performance meets all pertinent standards: UL Component Recognized, CSA, CE and ARI 780—insuring long service life and suitability in the application. All ratings meet 6x, 5x, 4x locked rotor amp rating at 240, 480 and 600V respectively. Tested for endurance per ARI 780, all contactors meet or exceed for 500,000 mechanical and 200,000 electrical operations.



Definite Purpose Controls Full Voltage Contactors

CR453A

2-pole and 3-pole
25A-40A

Cover permits visual on/off status indication. Short covers are standard for contactors with all screw terminals. Other contactors feature a standard long cover.

The use of advanced thermoplastics increases contactor performance, allows better appearance, enhances the overall quality and improves the clarity of the terminal markings.

Multiple terminal configurations on line and load terminals allow selection of the right terminals for the job. Choose from hex head screw terminals with slotted/Phillips head or box lug terminals, all with or without quick connect accessory terminals.

Quick connects are integral to the terminal to provide strength and reliability. Silver alloy contacts are strip welded for superior bond, resulting in long life and weld resistance.

Coils can be replaced without tools and are enclosed for protection from outside contaminants. Their reversible design permits top or bottom wiring without inverting the contactors.

New contactors are 20% smaller but still deliver 100% of the performance and quality.

Toolless, snap on accessories make factory and field modifications simple and easy while delivering time savings and late point flexibility.

Class 20 and Class 10 overloads are available.

Low VA "no burn" coil design allows minimum CPT sizing requirement and failsafe reliability during brownout conditions. Features standard slotted/Phillips screw with 1/4" dual quick connect terminals for ease of wiring.

Universal mounting plate with multiple elongated holes allow contactors to be used in same mounting holes as existing designs—allowing easy replacement or simple substitution. DIN rail mount is available.

Contactors form a "pokayoke" assembly. They are keyed so that it is impossible to put them together incorrectly. This makes for easy, foolproof assembly.

Outstanding performance meets all pertinent standards: UL Component Recognized, CSA, CE and ARI 780—insuring long service life and suitability in the application. All ratings meet 6x, 5x, 4x locked rotor amp rating at 240, 480 and 600V respectively.

Tested for endurance per ARI 780, all contactors meet or exceed 500,000 mechanical and 200,000 electrical operations.

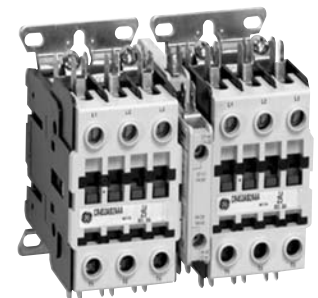

Definite Purpose Controls

Full Voltage Contactors

Section 4

CR453C

Compact
Single Phase
20A-40A

Standard Forms

Standard CR453C contactors feature hex screws with #2 Phillips/slotted heads on the 20-35FLA devices and box lugs on 40FLA forms. Each pole is supplied with four 1/4" quick connect terminals. Coils are provided with two 1/4" quick connect terminals.

For configurations not found below see page 4-5 for Factory Modified Forms.

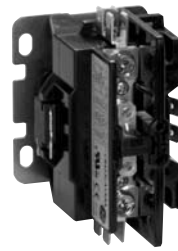

25A-35A 1 pole

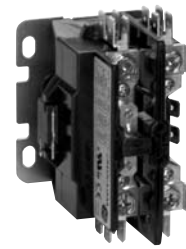

25A-35A
1 pole + shunt

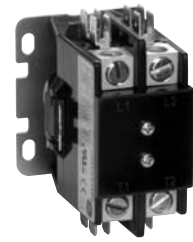

40A 2 pole

CR453C Compact (1, 1 + shunt & 2 pole)

Inductive Amps	Resistive Amps	Locked Rotor Amps, 50/60 Hz @ 240/277V	Locked Rotor Amps, 50/60 Hz @ 480V	Locked Rotor Amps, 50/60 Hz @ 600V	No. of Poles	Product Number	List Price GO-10DP
20	30	120	100	80	1	CR453CA1*AA	\$24.00
20	30	120	100	80	1 + Shunt	CR453CA3*AA	\$29.00
20	30	120	100	80	2	CR453CA2*AA	\$32.00
25	35	150	125	100	1	CR453CB1*AA	\$30.00
25	35	150	125	100	1 + Shunt	CR453CB3*AA	\$36.00
25	35	150	125	100	2	CR453CB2*AA	\$40.00
30	40	180	150	120	1	CR453CC1*AA	\$32.00
30	40	180	150	120	1 + Shunt	CR453CC3*AA	\$38.00
30	40	180	150	120	2	CR453CC2*AA	\$42.00
35	50	180	150	120	1	CR453CD1*AA	\$35.00
35	50	180	150	120	1 + Shunt	CR453CD3*AA	\$44.00
35	50	210	175	140	2 ¹	CR453CD2*AA	\$46.00
40	50	240	200	160	2 ¹	CR453CE2*BB	\$50.00

¹Ratings shown are for single phase, 2-pole. See page 4-24 for single phase, 1-pole ratings.

(Replace * in product number with appropriate coil digit.)

Coil Selection

CR453C Compact Coil Selection

Coil Voltage		Product Number Digit
60 Hz	50 Hz	
24	24	H
110-120	110	A
208-240	208-220	B
277	—	F



Definite Purpose Controls

Full Voltage Contactors

Section 4

CR453A

Standard
Single Phase
25A-40A

Standard Forms

On standard CR453A contactors, the coil and each power pole are supplied with two 1/4" quick connect terminals. Standard 25 FLA and 30 FLA contactors feature hex screws with #2 Phillips/slotted heads and short covers. Standard 40 FLA contactors come with box lugs and long covers.

For configurations not found below see page 4-7 for Factory Modified Forms.



25A-30A with screw terminals and short cover

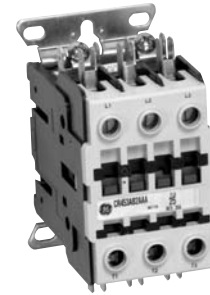

40 A with box lugs and long cover

CR453A Standard (2 and 3 pole)

Inductive Amps	Resistive Amps	50/60 Hz						Single Phase	Single Phase	No. of Poles	Product Number	List Price GO-10DP
		Three Phase 240V HP	Three Phase 240V LRA	Three Phase 480V HP	Three Phase 480V LRA	Three Phase 600V HP	Three Phase 600V LRA	50/60 Hz 120V HP	50/60 Hz 240V HP			
25	35	7.5	150	10	125	10	100	2	3	2	CR453AB2*AA	\$47.00
25	35	7.5	150	10	125	10	100	2	3	3	CR453AB3*AA	\$53.00
30	40	10	180	15	150	15	120	2	5	2	CR453AC2*AA	\$53.00
30	40	10	180	15	150	15	120	2	5	3	CR453AC3*AA	\$59.00
40	50	10	240	20	200	20	160	3	7.5	2	CR453AD2*BB	\$64.00
40	50	10	240	20	200	20	160	3	7.5	3	CR453AD3*BB	\$71.00

(Replace * in product number with appropriate coil digit.)

Coil Selection

CR453A Coil Selection

Coil Voltage		Product No. Digit
60 Hz	50 Hz	
12	12	E
24	24	H
110-120	110-120	A
208-240	208-240	B
277	—	F
440-480	380-415	C
550-600	550-600	D



Definite Purpose Controls Full Voltage Contactors

Section 4

CR353
Standard
Three Phase
4-pole
25A-40A

For configurations not found below see page 4-9 for Factory Modified Forms.

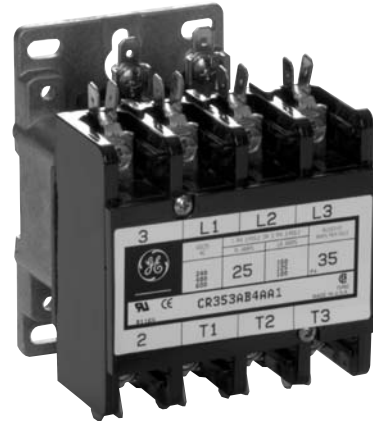

CR353A Contactor

CR353 Standard (4-pole)

Inductive Amps	Resistive Amps	Locked Rotor Amps, 50/60 Hz @ 240V	Locked Rotor Amps, 50/60 Hz @ 480V	Locked Rotor Amps, 50/60 Hz @ 600V	No. of Poles	Product Number	List Price GO-10DP
25	35	150	125	100	4	CR353AB4A*1	\$71.00
30	40	180	150	120	4	CR353AC4A*1	\$77.00
40	50	240	200	160	4	CR353AD4B*1	\$95.00

(Replace * in product number with appropriate coil digit.)

Coil Selection

CR353A Coil Selection

AC Coils

Coil Voltage		Product No. Digit
60 Hz	50 Hz	
24	24	H
110-120	110-120	A
208-240	208-240	B
277	—	F
415-480	415-480	C
575-600	550	D

DC Coils

Voltage DC	Product No. Digit	List Price Adder GO-10DP
12	P	\$36.00
24-48	R	\$36.00
125	S	\$36.00



Definite Purpose Controls Full Voltage Contactors

CR353

Standard
Three Phase
2-pole and 3-pole
50A - 150A

Standard Forms

Standard CR353 contactors in the 50-120FLA ratings are supplied with box lug terminals. Power poles in the 50-90FLA size are supplied with two 1/4" quick connect terminals. Contactors in the 120-150FLA size include control power accessory screws on L1 and L2. Coils are provided with screw connections with a single 1/4" quick connect terminal on the 50 and 60 amp size and two 1/4" quick connect terminals on the 75 and 90 amp size.

For configurations not found below see page 4-11 for Factory Modified Forms.



CR353 Contactor

CR353 Standard (2-pole and 3-pole)

Inductive Amps	Resistive Amps	Locked Rotor Amps, 50/60 Hz @ 240V	Locked Rotor Amps, 50/60 Hz @ 480V	Locked Rotor Amps, 50/60 Hz @ 600V	No. of Poles	Product Number	List Price GO-10DP
50	62	300	250	200	2	CR353FE2B*1	\$121.00
50	62	300	250	200	3	CR353FE3B*1	\$134.00
60	75	360	300	240	2	CR353FF2B*1	\$141.00
60	75	360	300	240	3	CR353FF3B*1	\$157.00
75	90	450	375	300	2	CR353EG2B*1	\$203.00
75	90	450	375	300	3	CR353EG3B*1	\$225.00
90	90	540	450	360	2	CR353EH2B*1	\$290.00
90	90	540	450	360	3	CR353EH3B*1	\$322.00
120	120	720	600	480	2	CR353GJ2A*1	\$423.00
120	120	720	600	480	3	CR353GJ3A*1	\$460.00
150	150	900	750	600	2	CR353GK2A*1	\$816.00
150	150	900	750	600	3	CR353GK3A*1	\$900.00

(Replace * in product number with appropriate coil digit.)

Coil Selection

CR353F, E, G Coil Selection

AC Coils

CR353F, E Coil Voltage		CR353G Coil Voltage		Product No. Digit
60 Hz	50 Hz	60 Hz	50 Hz	
24	24	—	—	H
110-120	110-120	115-120	110	A
208-240	208-240	230-240	220	B
277	—	277	—	F
460-480	440	460-480	440	C
575-600	550	575-600	550	D

DC Coils

CR353F Coil Voltage	CR353E Coil Voltage	Product No. Digit	List Price Adder GO-10DP
12	12	P	\$36.00
24-28	24-28	R	\$36.00
110-125	110-125	S	\$36.00
—	48	T	\$36.00



Definite Purpose Controls

2-Speed Contactors

CR455

Three Phase and Single Phase
25A-40A

Standard Forms

Standard CR455A 2-speed controllers consist of two contactors, a mechanical interlock and partially wired cross-electrical interlocks. The coil and each power pole are supplied with two 1/4" quick connect terminals. Standard 25 FLA and 30 FLA 2-speed controllers feature hex screws with #2 Phillips/slotted heads and short covers. Standard 40 FLA 2-speed controllers come with box lugs and long covers.

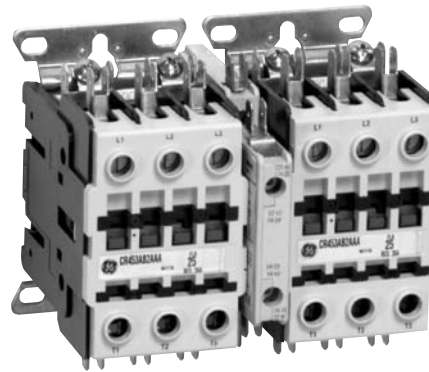

CR455 Contactor

CR455 Standard (2 and 3 pole)

Inductive Amps	Resistive Amps	Three Phase 240V HP	Three Phase 240V LRA	Three Phase 480V HP	Three Phase 480V LRA	Three Phase 600V HP	Three Phase 600V LRA	Single Phase 50/60 Hz 120V HP	Single Phase 50/60 Hz 240V HP	No. of Poles	Product Number	List Price GO-10DPA
25	35	7.5	150	10	125	10	100	2	3	2-3	CR455AB2*AAD	\$190.00
25	35	7.5	150	10	125	10	100	2	3	3-3	CR455AB3*AAD	\$202.00
30	40	10	180	15	150	15	120	2	5	2-3	CR455AC2*AAD	\$202.00
30	40	10	180	15	150	15	120	2	5	3-3	CR455AC3*AAD	\$214.00
40	50	10	240	20	200	20	160	3	7.5	2-3	CR455AD2*BBD	\$225.00
40	50	10	240	20	200	20	160	3	7.5	3-3	CR455AD3*BBD	\$239.00

(Replace * in product number with appropriate coil digit.)

Coil Selection

CR455 Coil Selection

Coil Voltage		Product No. Digit
60 Hz	50 Hz	
12	12	E
24	24	H
110-120	110-120	A
208-240	208-240	B
277	—	F
440-480	380-415	C
550-600	550-600	D



Definite Purpose Controls

2-Speed Contactors

CR355

2-Speed Controllers
25A - 90A

Standard Forms

Standard 2-speed controllers consist of two contactors, a mechanical interlock and partially wired cross-electrical interlocks.

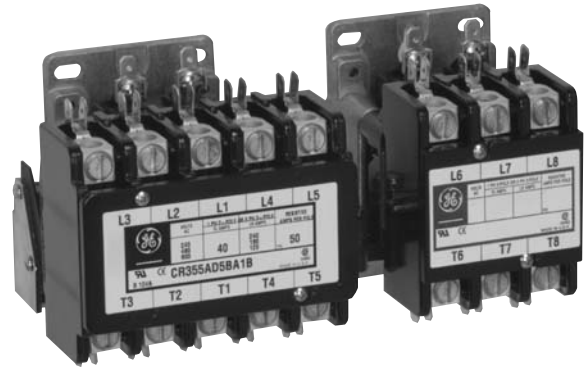

CR355 Contactor

CR355 Standard (4-4 and 5-3 pole)

Inductive Amps	Resistive Amps	Locked Rotor Amps, 50/60 Hz @ 240V	Locked Rotor Amps, 50/60 Hz @ 480V	Locked Rotor Amps, 50/60 Hz @ 600V	No. of Poles	Product Number	List Price GO-10DPA
25	35	150	125	100	4-4	CR355AB4A*1B	\$232.00
25	35	150	125	100	5-3	CR355AB5A*1B	\$232.00
30	40	180	150	120	4-4	CR355AC4A*1B	\$245.00
30	40	180	150	120	5-3	CR355AC5A*1B	\$245.00
40	50	240	200	160	4-4	CR355AD4B*1B	\$279.00
40	50	240	200	160	5-3	CR355AD5B*1B	\$279.00

(Replace * in product number with appropriate coil digit.)

Coil Selection

CR355 Coil Selection

Coil Voltage		Product No. Digit
60 Hz	50 Hz	
24	24	H
110-120	110-120	A
208-240	208-240	B

CR355 Standard (2-3 and 3-3 pole)

Inductive Amps	Resistive Amps	Locked Rotor Amps, 50/60 Hz @ 240V	Locked Rotor Amps, 50/60 Hz @ 480V	Locked Rotor Amps, 50/60 Hz @ 600V	No. of Poles	Product Number	List Price GO-10DPA
50	—	300	250	200	2-3	CR355EE2B*1C	\$295.00
50	—	300	250	200	3-3	CR355EE3B*1C	\$309.00
60	—	360	300	240	2-3	CR355EF2B*1C	\$338.00
60	—	360	300	240	3-3	CR355EF3B*1C	\$354.00
75	90	450	375	300	2-3	CR355EG2B*1C	\$467.00
75	90	450	375	300	3-3	CR355EG3B*1C	\$490.00
90	90	540	450	360	2-3	CR355EH2B*1C	\$652.00
90	90	540	450	360	3-3	CR355EH3B*1C	\$684.00

(Replace * in product number with appropriate coil digit.)

Coil Selection

CR355 Coil Selection

CR355EE, EF Coil Voltage		CR355EG, EH Coil Voltage		Product No. Digit
60 Hz	50 Hz	60 Hz	50 Hz	
24	24	24	24	H
110-120	110-120	110-120	110-120	A
208-240	208-240	208-240	208-240	B



Definite Purpose Controls 2-Speed Contactors

Section 4

CR455

Three Phase and Single Phase
Factory Modified Forms
25A-40A

Factory Installed Modifications

CR455 Definite Purpose Two-speed Controllers, 25A-40A

Select two-speed contactor from the main table and complete the product number by inserting the digits corresponding to required and optional specifications from the tables below. 2-speed controllers with line and load screw terminals will be supplied with short covers, and all others will be supplied with long covers. Note: factory modified forms require minimum orders/additional multiples. See page 4-34 for bulk pack details.

Full Load Amps	Three Phase, 50/60 Hz						Single Phase HP, 50/60 Hz											List Price GO-10DPA					
	240V		480V		600V		(Complete by adding digits from tables below ¹)																
	HP	LRA	HP	LRA	HP	LRA	Required Digits																
25	7.5	150	10	125	10	100	2	3	2-3	C	R	4	5	5	A	B	2	Options				D	\$190.00
25	7.5	150	10	125	10	100	2	3	3-3	C	R	4	5	5	A	B	3	Options				D	\$202.00
30	10	180	15	150	15	120	2	5	2-3	C	R	4	5	5	A	C	2	Options				D	\$202.00
30	10	180	15	150	15	120	2	5	3-3	C	R	4	5	5	A	C	3	Options				D	\$214.00
40	10	240	20	200	20	160	3	7.5	2-3	C	R	4	5	5	A	D	2	Options				D	\$217.50
40	10	240	20	200	20	160	3	7.5	3-3	C	R	4	5	5	A	D	3	Options				D	\$230.00

¹If no options are required, product number is complete after 12 digits.

Digit 9 Coil Selection

Coil Voltage	Product No. Digit 9
60 Hz	
12	E
24	H
110-120	A
208-240	B
277	F
440-480	C
550-600	D

Digits 13 & 14 Auxiliary Contacts

Volts	Product No. Digits 13 & 14	Contacts	List Price Adder GO-10DPA
250	00	None (standard) ²	\$0.00
250	1L	1 SPDT Left	\$16.00
250	1R	1 SPDT Right	\$16.00
250	2L	2 SPDT Left	\$30.00
250	2R	2 SPDT Right	\$30.00
250	2S	1 SPDT Left & Right	\$32.00
250	4S	2 SPDT Left & Right	\$60.00
600	10	1 NO-NC Left	\$40.00
600	01	1 NO-NC Right	\$40.00
600	11	1 NO-NC Left & Right	\$80.00
600	12	1 NO-NC Left, 2 NO Right	\$80.00
600	20	2 NO Left	\$40.00
600	02	2 NO Right	\$40.00
600	22	2 NO Left & Right	\$80.00
600	21	2 NO Left, 1 NO-NC Right	\$80.00

Digit 10 Line Terminals

Product No. Digit 10	Terminal Type	List Price Adder, GO-10DPA			
		2-3 poles, 25-30FLA	2-3 poles 40FLA	3-3 poles 25-30FLA	3-3 poles 40FLA
A	Screw w/ Quick Connect	\$0.00	\$3.75	\$0.00	\$4.50
B	Lug w/ Quick Connect	\$3.75	\$3.75	\$4.50	\$4.50
C	Screw	\$0.00	\$3.75	\$0.00	\$4.50
D	Lug	\$3.75	\$3.75	\$4.50	\$4.50
L	Sems Clamp w/ 1/4" Quick Connect	\$6.25	\$6.25	\$7.50	\$7.50
M	Sems Clamp	\$5.00	\$5.00	\$6.00	\$6.00

Digit 15 Modifications

Product No. Digit 15	Modification	List Price Adder GO-10DPA
A	None (standard) ²	\$0.00
B	Coil rotated (terminal on load side)	\$4.00
C	DIN rail clip option	\$14.00
D	No cover (available on screw terminal forms only)	\$0.00
G	Coil rotated & DIN rail clip option	\$18.00

Digit 11 Load Terminals

Product No. Digit 11	Terminal Type	List Price Adder, GO-10DPA			
		2-3 poles, 25-30FLA	2-3 poles 40FLA	3-3 poles 25-30FLA	3-3 poles 40FLA
A	Screw w/ Quick Connect	\$0.00	\$3.75	\$0.00	\$4.50
B	Lug w/ Quick Connect	\$3.75	\$3.75	\$4.50	\$4.50
C	Screw	\$0.00	\$3.75	\$0.00	\$4.50
D	Lug	\$3.75	\$3.75	\$4.50	\$4.50
L	Sems Clamp w/ 1/4" Quick Connect	\$6.25	\$6.25	\$7.50	\$7.50
M	Sems Clamp	\$5.00	\$5.00	\$6.00	\$6.00

Digit 16 Nameplate Marking

Product No. Digit 16	Specials	List Price Adder GO-10DPA
A	None (standard) ²	\$0.00
	Request from Factory (Custom) ⁴	\$9.00

Digit 17 Packaging

Product No. Digit 17	Specials	List Price Adder GO-10DPA
Blank	Single	\$0.00
P	Bulk pack ³	\$0.00

²If this will be the final digit(s) in your selection, omit from product number.

³Requires minimum order quantities. See page 4-34 for details.

⁴For special nameplate markings, contact factory.



Definite Purpose Controls Full Voltage Starters

CR454

Three Phase and Single Phase
3-pole
25A-40A

Standard Forms

Standard CR454A starters consist of contactors and overload relays. (For starters with holding interlocks, see factory modified forms on page 4-17.) The coil and each power pole are supplied with two 1/4" quick connect terminals. Standard 25 FLA and 30 FLA starters feature hex screws with #2 Phillips/slotted heads and short covers. Standard 40 FLA starters come with box lugs and long covers.

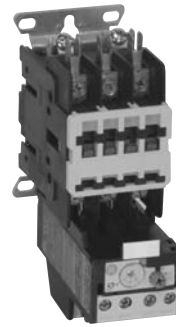

25A-30A with screw terminals
and short cover

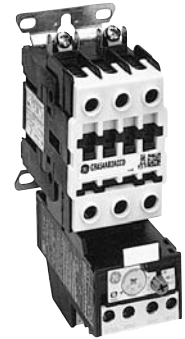

40 A with box lugs
and long cover

CR454 25A-40A 3-pole

Full load amps	Resistive per Pole	Three Phase Horsepower @ 240V	Locked Rotor Amps @ 240V	Three Phase Horsepower @ 480V	Locked Rotor Amps @ 480V	Three Phase Horsepower @ 600V	Locked Rotor Amps @ 600V	Single Phase Horsepower @ 115V	Single Phase Horsepower @ 230V	No. of Poles	Product Number	List Price GO-10DPA
25	35	7.5	150	10	125	10	100	2	3	3	CR454AB3*A# ¹	\$78.00
30	40	10	180	15	150	15	120	2	5	3	CR454AC3*A# ¹	\$84.00
40	50	10	240	20	200	20	160	3	7.5	3	CR454AD3*B# ¹	\$96.00

¹For single phase starters, wire 2 poles in series.

(Replace * in product number with appropriate coil digit.)

Coil Selection

CR454 Coil Selection

Coil Voltage		Product No. Digit
60 Hz	50 Hz	
12	12	E
24	24	H
110-120	110-120	A
208-240	208-240	B
277	—	F
440-480	380-415	C
550-600	550-600	D

(Replace # in product number with appropriate overload digit.)

Overload Selection

Select range corresponding to full load amps. Overloads are Class 20, ambient compensated. For starters with lower overload amp ranges, see page 4-17.

Overload Amp Range	Product No. Digit	List Price Adder GO-10DPA	Overload Amp Range	Product No. Digit	List Price Adder GO-10DPA
2.5-4.1	K	\$55.00	14.5-18	S	\$57.00
4-6.3	L	\$55.00	17.5-22	T	\$57.00
5.5-8.5	M	\$57.00	21-26	U	\$57.00
8-12	N	\$57.00	25-32	V	\$63.00
10-16	P	\$57.00	30-40	W	\$78.00



Definite Purpose Controls Full Voltage Starters

Section 4

CR454

Three Phase and Single Phase
Factory Modified Forms
25A-40A

Factory Installed Modifications

CR454 Definite Purpose Starters, 25A-40A

Select your starter from the main table and complete the product number by inserting the digits corresponding to required and optional specifications from the tables below. For holding interlocks, select the appropriate auxiliary contact for Digits 13-14. Starters with screw line terminals will be supplied with short covers, and all others will be supplied with long covers. Note: all factory modified forms require minimum orders/additional multiples. See page 4-34 for bulk pack details.

Full Load	Resistive Amps	Three Phase, 50/60 Hz						Single Phase HP ²		Product Number (Complete by adding digits from tables below ¹)																			
		240V		480V		600V		120V	240V	Required Digits									Options										
List Price	Amps	HP	LRA	HP	LRA	HP	LRA	120V	240V	Poles	1	2	3	4	5	6	7	8	9	10	11	12	13	14	15	16	17	GO-10DPA	
25	35	7.5	150	10	125	10	100	2	3	3	C	R	4	5	4	A	B	3											\$78.00
30	40	10	180	15	150	15	120	2	5	3	C	R	4	5	4	A	C	3											\$84.00
40	50	10	240	20	200	20	160	3	7.5	3	C	R	4	5	4	A	D	3											\$93.75

¹If no options are required, product number is complete after 11 digits.

²For single phase starters, wire 2 poles in series.

Digit 9 Coil Selection

Coil Voltage		Product No. Digit 9
60 Hz	50 Hz	
12	12	E
24	24	H
110-120	110-120	A
208-240	208-240	B
277	—	F
440-480	380-415	C
550-600	550-600	D

Digit 12 Terminal Identification

Product No. Digit 12	Special Mark	List Price Adder GO-10DPA
A	Standard ³ Top: L1, L2, L3 Bottom: T1, T2, T3	\$0.00
D	No markings	\$1.00

Digit 10 Line Terminals

Product No. Digit 10	Terminal Type	25-30FLA	40FLA	List Price Adder GO-10DPA
A	Screw w/ Quick Connect	\$0.00	\$2.25	
B	Lug w/ Quick Connect	\$2.25	\$2.25	
C	Screw	\$0.00	\$2.25	
D	Lug	\$2.25	\$2.25	
L	Sems Clamp w/ 1/4" Quick Connect	\$3.75	\$3.75	
M	Sems Clamp	\$3.00	\$3.00	

Digits 13 & 14 Auxiliary Contacts

Volts	Product No. Digits 13 & 14	Contacts	List Price Adder GO-10DPA
250	00	None (standard) ³	\$0.00
250	1L	1 SPDT Left	\$16.00
250	1R	1 SPDT Right	\$16.00
250	2L	2 SPDT Left	\$30.00
250	2R	2 SPDT Right	\$30.00
250	2S	1 SPDT Left & Right	\$32.00
250	4S	2 SPDT Left & Right	\$60.00
600	10	1 NO-NC Left	\$40.00
600	01	1 NO-NC Right	\$40.00
600	11	1 NO-NC Left & Right	\$80.00
600	12	1 NO-NC Left, 2 NO Right	\$80.00
600	20	2 NO Left	\$40.00
600	02	2 NO Right	\$40.00
600	22	2 NO Left & Right	\$80.00
600	21	2 NO Left, 1 NO-NC Right	\$80.00

Digit 11 Overload

Select range corresponding to full load amps. Overload digits B-J are Class 10 and require the selection of 1 or 2 for Digit 15. Overload digits K-W are available for Class 10 or Class 20.

For Use With 25A-40A Contactor		
Overload Amp Range	Product No. Digit 11	List Price Adder GO-10DPA
0.16-0.26	B	\$55.00
0.25-0.41	C	\$55.00
0.4-0.65	D	\$55.00
0.65-1.1	F	\$55.00
1-1.5	G	\$55.00
1.3-1.9	H	\$55.00
1.8-2.7	J	\$55.00
2.5-4.1	K	\$55.00
4-6.3	L	\$55.00
5.5-8.5	M	\$57.00
8-12	N	\$57.00
10-16	P	\$57.00
14.5-18	S	\$57.00
17.5-22	T	\$57.00
21-26	U	\$57.00
25-32	V	\$65.00
30-40	W	\$78.00

Digit 15 Modifications

Product No. Digit 15	Modification	List Price Adder GO-10DPA
A	No modifications (standard) ³ Class 20 overload). Applies only to overloads K-W in Digit 11	\$0.00
C	DIN rail clip option w/Class 20 OLR	\$7.00
1	Class 10 overload	\$0.00
2	DIN rail clip option w/Class 10 OLR	\$9.00

Digit 16 Nameplate Marking/Enclosure Option

Product No. Digit 16	Specials	List Price Adder GO-10DPA
A	None (standard) ³	\$0.00
E	Starter assembled in CR453XEA1 enclosure	\$62.00
	Request from Factory (Custom) ⁴	\$9.00

Digit 17 Packaging

Product No. Digit 17	Specials	List Price Adder GO-10DPA
Blank	Single	\$0.00
P	Bulk pack (requires minimum order quantities; see page 4-34 for details.)	\$0.00

³If this will be the final digit in your selection, omit from product number.

⁴For special nameplate markings, contact factory.



Definite Purpose Controls Full Voltage Starters

CR354F

Three Phase and Single Phase
2-pole and 3-pole
50A-60A

Standard Forms

Standard starters consist of contactors and overload relays. For starters with holding interlocks, see factory modified forms on page 4-18.



CR354 Starter

CR354 50A-60A 2-pole and 3-pole

Full load amps	Locked Rotor Amps @ 240V	Locked Rotor Amps @ 480V	Locked Rotor Amps @ 600V	Motor Type	No. of Poles	Overload Heaters	NO Aux Contact (10A, 250 Vac)	Overload Type	Product Number	List Price GO-10DPA
50	300	250	200	1	2	1	—	Standard Overload	CR354FE2B*3 ¹	\$242.00
50	300	250	200	1	2	1	1	Standard Overload	CR354FE2B*3B ¹	\$254.00
50	300	250	200	1	2	1	—	Ambient Compensated Overload	CR354FE2B*4 ¹	\$258.00
50	300	250	200	1	2	1	1	Ambient Compensated Overload	CR354FE2B*4B ¹	\$270.00
50	300	250	200	3	3	3	—	Standard Overload	CR354FE3B*3 ¹	\$336.00
50	300	250	200	3	3	3	1	Standard Overload	CR354FE3B*3B ¹	\$348.00
50	300	250	200	3	3	3	—	Ambient Compensated Overload	CR354FE3B*4 ¹	\$352.00
50	300	250	200	3	3	3	1	Ambient Compensated Overload	CR354FE3B*4B ¹	\$364.00
60	360	300	240	1	2	1	—	Standard Overload	CR354FF2B*3 ¹	\$282.00
60	360	300	240	1	2	1	1	Standard Overload	CR354FF2B*3B ¹	\$294.00
60	360	300	240	1	2	1	—	Ambient Compensated Overload	CR354FF2B*4 ¹	\$298.00
60	360	300	240	1	2	1	1	Ambient Compensated Overload	CR354FF2B*4B ¹	\$310.00
60	360	300	240	3	3	3	—	Standard Overload	CR354FF3B*3 ¹	\$393.00
60	360	300	240	3	3	3	1	Standard Overload	CR354FF3B*3B ¹	\$405.00
60	360	300	240	3	3	3	—	Ambient Compensated Overload	CR354FF3B*4 ¹	\$409.00
60	360	300	240	3	3	3	1	Ambient Compensated Overload	CR354FF3B*4B ¹	\$421.00

¹For Heater Selection, see page 4-19.

(Replace * in product number with appropriate coil digit.)

Coil Selection

CR354 Coil Selection

Coil Voltage		Product No. Digit
60 Hz	50 Hz	
24	24	H
110-120	110-120	A
208-240	208-240	B
277	—	F
415-480	415-480	C
575-600	550	D



Definite Purpose Controls Full Voltage Starters

Section 4

CR354F

Three Phase and Single Phase
Factory Modified Forms
50A-60A

Factory Installed Modifications

CR354F, 50A-60A, 2-pole and 3-pole

Select your contactor from the main table and complete the product number by inserting the digits corresponding to required and optional specifications from the tables below. Note: minimum order quantities apply to all factory modified forms. Contact factory for details.

Full Load Amps	Locked Rotor Amps Three Phase, 60 Hz			Phase	Poles	Overload Heaters	Product Number (Complete by adding digits from tables below ¹)											Opt. 12	List Price GO-10DPA
	240V	480V	600V				Required Digits												
	1	2	3				4	5	6	7	8	9	10	11					
50	300	250	200	1	2	1	C	R	3	5	4	F	E	2	B		\$242.00		
50	300	250	200	3	3	3	C	R	3	5	4	F	E	3	B		\$336.00		
60	360	300	240	1	2	1	C	R	3	5	4	F	F	2	B		\$282.00		
60	360	300	240	3	3	3	C	R	3	5	4	F	F	3	B		\$393.00		

¹If no options are required, product number is complete after 11 digits.

Digit 10 Coil Selection

Coil Voltage		Product No. Digit 10
60 Hz	50 Hz	
24	24	H
110-120	110-120	A
208-240	208-240	B
277	—	F
460-480	440	C
575-600	550	D

Digit 11 Overload Relay

Product No. Digit 11	Overload Relay	List Price Adder GO-10DPA
3	Standard	\$0.00
4	Ambient Compensated	\$16.00

Digit 12 Auxiliary Contacts

Product No. Digit 12	Auxiliary Contacts	List Price Adder GO-10DPA
Blank	None	\$0.00
B	10A, 250V, SPDT, left side	\$16.00
C	10A, 250V, SPDT, left & right	\$32.00



Definite Purpose Controls Full Voltage Starters

CR354

Three Phase and Single Phase
Heaters
50A-60A

Standard or ambient compensated overload relays, Open or Type 1 Enclosed

To prevent overloading the starter, do not select heater(s) for a motor with a rating larger than the maximum shown on the starter nameplate. If a motor's full-load amps fall between two ratings, select heaters with the higher of the two ratings.

For continuous rated motors with a service factor of 1.15 to 1.25, select the heater with maximum motor amps equal to or immediately greater than the motor full-load current. This will provide a maximum of 125% protection. For continuous rated motors with no service factor, multiply the full-load current of the motor by 0.9 and use the resulting value to select the heater.

To protect the heater and starter during a short circuit, provide motor branch circuit protection in accordance with Table 420-152 in Article 430 of the National Electrical Code. In no case should the fuse rating exceed 4 times the motor full-load current for single-element fuses or 2.25 times the motor full-load current for dual-element fuses.

Do not use these tables to select heaters for hermetic motor applications. Contact your GE Energy sales office for information.

Heater amps are based on 75°C wire. All heaters are packaged 3 per carton and carry a **List Price of \$9.00, GO-10H.**

Three Phase (3 heaters required)

Max. Motor FLA		
50A Starter	60A Starter	Product Number
6.07	5.14	CR123C630A
6.63	5.63	CR123C695A
7.35	6.26	CR123C778A
8.09	7.15	CR123C867A
8.89	7.58	CR123C955A
9.78	8.39	CR123C104B
10.8	9.11	CR123C113B
11.8	9.67	CR123C125B
13.0	11.0	CR123C137B
14.5	12.0	CR123C151B
16.1	14.4	CR123C163B
17.9	16.3	CR123C180B
19.8	17.3	CR123C198B
22.0	19.3	CR123C214B
24.4	20.9	CR123C228B
27.1	22.9	CR123C250B
29.9	24.7	CR123C273B
34.1	28.0	CR123C303B
38.8	32.1	CR123C330B
44.3	35.9	CR123C366B
50.0	41.5	CR123C400B
—	43.4	CR123C440B
—	46.4	CR123C460B
—	50.9	CR123C500B
—	56.9	CR123C550B
—	60.0	CR123C600B

Single phase (1 heater required)

Max. Motor FLA		
50A Starter	60A Starter	Product Number
6.15	6.15	CR123C592A
6.47	6.47	CR123C630A
6.84	6.84	CR123C695A
7.72	7.72	CR123C778A
8.99	8.99	CR123C867A
9.87	9.87	CR123C955A
10.6	10.6	CR123C104B
12.0	12.0	CR123C113B
12.3	12.3	CR123C125B
14.0	14.0	CR123C137B
15.7	15.7	CR123C151B
17.6	17.6	CR123C163B
20.1	20.1	CR123C180B
23.3	23.3	CR123C198B
27.0	27.0	CR123C214B
29.8	29.8	CR123C228B
32.2	32.2	CR123C250B
33.9	33.9	CR123C273B
36.7	36.7	CR123C303B
42.5	42.5	CR123C330B
46.2	46.2	CR123C366B
50.0	50.0	CR123C400B
—	52.4	CR123C440B
—	58.2	CR123C460B
—	60.0	CR123C500B



Definite Purpose Controls Full Voltage Contactors

Section 4

CR453A

Standard
Accessories
25A-40A

Auxiliary Contact Kits

Contactor Prefix	Contactor Rating	Description	Product Number	List Price GO-10DP
CR453A	25A-40A 2-3 pole	250V, Side Mounted, SPDT	CR453XC211	\$16.00
CR453A	25A-40A 2-3 pole	250V, Side Mounted, Two SPDT	CR453XC222	\$30.00
CR453A	25A-40A 2-3 pole	600V, Side Mounted, 1NO-1NC (BCLL11 with quick-connects)	CR453XC611	\$40.00
CR453A	25A-40A 2-3 pole	600V, Side Mounted, 2 NO (BCLL20 with quick-connects)	CR453XC620	\$40.00
CR453A	25A-40A 2-3 pole	Mechanical & electrical interlock with 2 NC aux contacts (BELO2 with quick-connects)	CR453XM602	\$65.00
CR453A	25A-40A 2-3 pole	DIN Rail Clip (sold only in multiples of 10)	CR453XDCA	\$7.00 ea.
CR353A, CR353F	50A-60A	SPDT	CR353XAAA	\$16.00
CR353F	75A-90A	SPDT	CR353XAAB	\$20.00
CR353G	120A-150A	1NO-1NC	CR353XADC	\$32.00



Auxiliary Contact Kits

C-2000 Accessories

For more information, see the C-2000 Contactors and Starters Purchasing Guide (DEP-014). For use with CR45* devices.

Accessory Type	Mounting Type	Contact Configuration	Type of Kit	Product Number	List Price GO-10C2
Auxiliary Contact Blocks	Front-Mount	1NO	—	BCLF10	\$11.00
Auxiliary Contact Blocks	Front-Mount	1NC	—	BCLF01	\$11.00
Auxiliary Contact Blocks	Side-Mount	1NO-1NC	—	BCLL11	\$19.00
Auxiliary Contact Blocks	Side-Mount	2NO	—	BCLL20	\$19.00
Mechanical Interlock	—	2NC	—	BELA02	\$35.00
Miscellaneous Kits	—	—	35 mm DIN Rail (1 meter)	CLXR35	\$8.00



Front-Mount Auxiliary Contact Block

Overload Relays

Direct mount, manual/auto reset (stop/reset only). Requires contactor with sems clamp terminal (without quick connects) on load side. Select M for Digit 11 on page 4-7.

Current Range Amps(min-max)	Maximum Fuse Rating Amps	Maximum Circuit Breaker Rating Amps	Trip Class	Product Number	List Price GO-10C2
0.16-0.26	1	15	Class 10	RT1B	\$55.00
0.25-0.41	1	15	Class 10	RT1C	\$55.00
0.4-0.65	3	15	Class 10	RT1D	\$55.00
0.65-1.1	6	15	Class 10	RT1F	\$55.00
1-1.5	6	15	Class 10	RT1G	\$55.00
1.3-1.9	6	15	Class 10	RT1H	\$55.00
1.8-2.7	10	15	Class 10	RT1J	\$55.00
2.5-4.1	15	15	Class 10	RT1K	\$55.00
4-6.3	20	15	Class 10	RT1L	\$55.00
5.5-8.5	25	15	Class 10	RT1M	\$57.00
8.0-12.0	40	30	Class 10	RT1N	\$57.00
10.0-16.0	50	35	Class 10	RT1P	\$57.00
14.5-18	60	40	Class 10	RT1S	\$57.00
17.5-22	70	50	Class 10	RT1T	\$57.00
21-26	80	60	Class 10	RT1U	\$57.00
25-32	100	80	Class 10	RT1V	\$65.00
30-40	100	80	Class 10	RT1W	\$78.00
2.5-4.1	15	15	Class 20	RT12K	\$55.00
4-6.3	20	15	Class 20	RT12L	\$55.00
5.5-8.5	25	15	Class 20	RT12M	\$57.00
8.0-12.0	40	30	Class 20	RT12N	\$57.00
10.0-16.0	50	35	Class 20	RT12P	\$57.00
14.5-18	60	40	Class 20	RT12S	\$57.00
17.5-22	70	50	Class 20	RT12T	\$57.00
21-26	80	60	Class 20	RT12U	\$57.00
25-32	100	80	Class 20	RT12V	\$65.00
30-40	100	80	Class 20	RT12W	\$78.00



Mechanical Interlock



DIN-Rail Kit



Overload Relay, Class 10



Definite Purpose Controls

Full Voltage Contactors

CR453A, CR353

Standard
Accessories
25A-40A

Remote Electrical Reset for RT1 Overload Relays

Voltage 50/60 Hz AC/DC	Product Number	List Price GO-10C2
12	RTXRRB	\$55.00
24	RTXRRD	\$55.00
48	RTXRRG	\$55.00
110-120	RTXRRJ	\$55.00
220-240	RTXRRN	\$55.00
380-415	RTXRRU	\$55.00
440-480	RTXRRX	\$55.00



Remote Electrical Reset

Overload Base Adapter Panel Mount

Product Number	List Price GO-10C2
RTXP	\$12.00

Enclosure Kits NEMA Type 1

Contactor Prefix	Device	Rating	Product Number	List Price GO-10DP
CR453	Contactors/Starters	25A-40A, 1-3 pole	CR453XE1A	\$42.00
CR353	Contactors	25A-40A, 4-pole	CR353XE1BB	\$42.00
		50A-60A, 3-pole		
CR353	Contactors	75A-90A	CR353XE1BC	\$60.00
CR354	Starters	50A	CR353XE1AA	\$48.00



Start/Stop Push Button

Accessories for CR453XE1A Enclosure

Enclosure Accessory Type	Product Number	List Price GO-10C2
Start/Stop Push Button Without Light	CLXP1B	\$39.00
Start/Stop Push Button With Light—115 V	CLXP1C	\$112.00
Start/Stop Push Button With Light—230 V	CLXP2C	\$112.00
Start/Stop Push Button With Light—460 V	CLXP3C	\$112.00
Start/Stop Push Button With Light—575 V	CLXP1C4	\$112.00
H-O-A Switch	CLXP1D	\$39.00
On-off Switch	CLXP1E	\$39.00
Red Indicating Light (For use with H-O-A or ON/OFF selector switch)	CLXP1F ¹	\$67.00
Reset Kit (For starter enclosure)	CLXR11	\$8.00



H-O-A Switch

¹Each kit has three resistors allowing light to be used with all voltages 110 through 600.

Pneumatic Timers for CR453A Series

Type	Time Range	Contacts	Product Number	List Price GO-10C2
Time Delay On	0.1-30 seconds	1 NO-1 NC	BTLF30C	\$120.00
Time Delay On	1-60 seconds	1 NO-1 NC	BTLF60C	\$120.00
Time Delay Off	0.1-30 seconds	1 NO-1 NC	BTLF30D	\$120.00
Time Delay Off	1-60 seconds	1 NO-1 NC	BTLF60D	\$120.00

Surge Suppressors

Type	Voltage	Product Number	List Price GO-10C2
RC	24-48 VAC	BSLR2G	\$24.00
RC	50-127 VAC	BSLR2K	\$24.00
RC	130-240 VAC	BSLR2R	\$24.00
Diode	12-600 VAC	BSLDZ	\$24.00
Varistor	24-48 VAC/DC	BSLV3G	\$24.00
Varistor	50-127 VAC/DC	BSLV3K	\$24.00
Varistor	130-250 VAC/DC	BSLV3R	\$24.00
Varistor	380-500 VAC/DC	BSLV3U	\$24.00



On-Off Switch

Mechanical Latch Block for CR453A Series

Release Voltage	Product Number	List Price GO-10C2
24-32 VAC/DC	RMLFD	\$70.00
42-48 VAC/DC	RMLFG	\$70.00
110-125 VAC/DC	RMLFJ	\$70.00
208-277 VAC/DC	RMLFN	\$70.00
380-480 VAC/DC	RMLFU	\$70.00
500-600 VAC/DC	RMLFY	\$70.00



Reset Kit for Starter Enclosure



Definite Purpose Controls Full Voltage Contactors

Section 4

CR453A, CR353

Standard

Coils and Renewal Parts

25A-150A

AC Replacement Coil

Contactor Prefix	Inductive Amps	Coil Letter Code	Coil Voltage @ 60 Hz	Coil Voltage @ 50 Hz	Product Number	List Price GO-11G
CR453A, CR454A, CR455A	25-40	A	110-120	110-120	55-537283A	\$24.00
CR453A, CR454A, CR455A	25-40	B	208-240	208-240	55-537283B	\$24.00
CR453A, CR454A, CR455A	25-40	C	440-480	380-415	55-537283C	\$24.00
CR453A, CR454A, CR455A	25-40	D	550-600	550-600	55-537283D	\$24.00
CR453A, CR454A, CR455A	25-40	E	12	12	55-537283E	\$24.00
CR453A, CR454A, CR455A	25-40	F	277	—	55-537283F	\$24.00
CR453A, CR454A, CR455A	25-40	H	24	24	55-537283H	\$24.00
CR353A, CR354A, CR355A	25-40	A	110-120	110-120	55-B31A	\$24.00
CR353A, CR354A, CR355A	25-40	B	208-240	208-240	55-B31B	\$24.00
CR353A, CR354A, CR355A	25-40	C	415-480	415-480	55-B31C	\$24.00
CR353A, CR354A, CR355A	25-40	D	575-600	550	55-B31D	\$24.00
CR353A, CR354A, CR355A	25-40	F	277	—	55-B31F	\$24.00
CR353A, CR354A, CR355A	25-40	H (4 pole)	24	24	55-B31H	\$24.00
CR353A, CR354A, CR355A	25-40	H (2-3 pole)	24	24	55-B34H	\$24.00
CR353FE, CR353F, CR354FE, CR354F	50-60	A	110-120	110-120	55-B38A	\$30.00
CR353FE, CR353F, CR354FE, CR354F	50-60	B	208-240	208-240	55-B38B	\$30.00
CR353FE, CR353F, CR354FE, CR354F	50-60	C	440-480	380-415	55-B38C	\$30.00
CR353FE, CR353F, CR354FE, CR354F	50-60	D	575-600	550	55-B38D	\$30.00
CR353FE, CR353F, CR354FE, CR354F	50-60	F	277	—	55-B38F	\$30.00
CR353FE, CR353F, CR354FE, CR354F	50-60	H	24	24	55-B38H	\$30.00
CR355EE, CR355F	50-60	A	110-120	110-120	55-B21A	\$54.00
CR355EE, CR355F	50-60	B	208-240	208-240	55-B21B	\$54.00
CR355EE, CR355F	50-60	C	415-480	415-480	55-B21C	\$54.00
CR355EE, CR355F	50-60	D	575-600	550	55-B21D	\$54.00
CR355EE, CR355F	50-60	F	277	—	55-B21F	\$54.00
CR355EE, CR355F	50-60	H	24	24	55-B21H	\$54.00
CR353EG, CR353H, CR355EG, CR355H	75-90	A	110-120	110-120	55-B22A	\$60.00
CR353EG, CR353H, CR355EG, CR355H	75-90	B	208-240	208-240	55-B22B	\$60.00
CR353EG, CR353H, CR355EG, CR355H	75-90	C	440-480	380-415	55-B22C	\$60.00
CR353EG, CR353H, CR355EG, CR355H	75-90	D	575-600	550	55-B22D	\$60.00
CR353EG, CR353H, CR355EG, CR355H	75-90	F	277	—	55-B22F	\$60.00
CR353EG, CR353H, CR355EG, CR355H	75-90	H	24	24	55-B22H	\$60.00
CR353GJ	120	A	115-120	110	55-501336G002	\$148.00
CR353GJ	120	B	230-240	220	55-501336G003	\$148.00
CR353GJ	120	C	460-480	440	55-501336G004	\$148.00
CR353GJ	120	D	575-600	550	55-501336G005	\$148.00
CR353GK	150	A	115-120	110	55-501563G002	\$202.00
CR353GK	150	B	230-240	220	55-501563G003	\$202.00
CR353GK	150	C	460-480	440	55-501563G004	\$202.00
CR353GK	150	D	575-600	550	55-501563G005	\$202.00



Definite Purpose Controls Full Voltage Contactors

CR453A, CR353

Standard

Coils and Renewal Parts

25A - 150A

Replacement Contact Kits for CR353

Continuous Amp Rating	Poles Per Kit	Termination	Product Number	List Price GO-11GS
40A	4	Screw/Quick Connect	55-152313G111B	\$64.00
50A	1	Lug/Quick Connect	55-152313G216 ¹	\$32.00
90A	1	Lug/Quick Connect	55-152313G217	\$84.00
75A	1	Lug/Quick Connect	55-152313G218	\$58.00
60A	1	Lug/Quick Connect	55-152313G237 ²	\$35.00
120A	3	Pressure	55-152313G139	\$308.00
150A	3	Pressure	55-152313G140	\$418.00

¹For CR353EE and CR355EE, use 55-152313G150, List Price, \$26.00, GO-11GS.

²For CR353EF and CR355EF, use 55-152313G219, List Price, \$32.00, GO-11GS.



Definite Purpose Controls Full Voltage Contactors

Section 4

CR453C, CR453A, CR353

Technical Data
25A-150A

DP Contactors Compact

Product Family	Poles	Inductive Amps	Resistive Amps	Locked Rotor Amps, 50/60 Hz @ 240/277V	Locked Rotor Amps, 50/60 Hz @ 480V	Locked Rotor Amps, 50/60 Hz @ 600V	% Nominal Coil Voltage @ Pickup	% Nominal Coil Voltage @ Dropout	Wire Size Range AWG	Terminal Torque (lb.-in.)	Approx. Ship. Wt. (Lbs)
CR453CA	1 + shunt	20	30	120	100	80	85%	60%	16-8	20	0.7
CR453CA	2	20	30	120	100	80	85%	60%	16-8	20	0.7
CR453CB	1 + shunt	25	35	150	125	100	85%	60%	16-8	20	0.7
CR453CB	2	25	35	150	125	100	85%	60%	16-8	20	0.7
CR453CC	1 + shunt	30	40	180	150	120	85%	60%	16-8	20	0.7
CR453CC	2	30	40	180	150	120	85%	60%	16-8	20	0.7
CR453CD	1 + shunt	35	50	180	150	120	85%	60%	16-8	20	0.7
CR453CD	2	35	50	210	175	140	85%	60%	16-8	20	0.7
CR453CE	1 + shunt	40	50	180	150	120	85%	60%	14-4	40	0.7
CR453CE	2	40	50	240	200	160	85%	60%	14-4	40	0.7

DP Contactors Standard

Family	Type	Inductive Amps	Resistive Amps	Three Phase 240V LRA	Three Phase 480V LRA	Three Phase 600V LRA	Locked Rotor Amps, 50/60 Hz @ 240V	Locked Rotor Amps, 50/60 Hz @ 480V	Locked Rotor Amps, 50/60 Hz @ 600V	Part Winding Locked Rotor Amps @ 240V	Part Winding Locked Rotor Amps @ 480V	Part Winding Locked Rotor Amps @ 600V
CR453	AB	25	35	150	125	100	—	—	—	—	—	—
CR454	AC	30	40	180	150	120	—	—	—	—	—	—
CR455	AD	40	50	240	200	160	—	—	—	—	—	—
CR353	AB	25	35	150	125	100	150	125	100	150	125	100
CR355	AC	30	40	180	150	120	180	150	120	180	150	120
CR355	AD	40	50	180	150	120	240	200	160	192	192	160
CR353	FE	50	62	300	250	200	—	—	—	300	250	200
CR354	FF	60	75	360	300	240	—	—	—	360	300	240
CR353	GG	75	90	450	375	300	—	—	—	450	375	300
CR355	EH	90	90	540	450	360	—	—	—	540	450	360
CR353	GJ	120	120	720	600	480	—	—	—	720	600	480
CR353	GK	150	150	900	750	600	—	—	—	900	750	600

DP Contactors Standard (continued)

Family	Type	% Nominal Coil Voltage @ Pickup	% Nominal Coil Voltage @ Dropout	Wire Size Range AWG	Terminal Torque (lb.-in.)	Approx. Shipping Wt. (Lbs)
CR453	AB, AC, AD	≤ 85%	≤ 60%	16-8	20	0.7
CR454	AB, AC, AD	≤ 85%	≤ 60%	16-8	20	0.7
CR455	AB, AC, AD	≤ 85%	≤ 60%	14-4	40	0.7
CR353	AB, AC, AD	≤ 85%	≤ 50%	16-8	20	1.5
CR355	AB, AC, AD	≤ 85%	≤ 50%	16-8	20	4.3
CR355	AB, AC, AD	≤ 85%	≤ 50%	14-4	40	4.3
CR353	FE, FF	≤ 85%	≤ 60%	14-2	50	1.9
CR354	FE, FF	≤ 85%	≤ 60%	14-2	50	3.5
CR353	GG	≤ 85%	≤ 55%	14-2/0	50	4.0
CR355	EH	≤ 85%	≤ 55%	14-2/0	50	8.1
CR353	GJ	≤ 85%	≤ 65%	8/3/0	200	17.5
CR353	GK	≤ 85%	≤ 65%	8/3/0	200	17.5



Definite Purpose Controls

Full Voltage Contactors

CR453C, CR453A, CR353

Technical Data
25A-150A

Section 4

CR453C CE Technical Data

Product Number	Electrical Rating AC1 @ 480V	Electrical Rating AC3 @ 240V	Electrical Rating AC3 @ 480V	UL File No.
CR453CA1*AA	30A	20A	16.7A	E126105
CR453CB1*AA	35A	25A	20.8A	E126105
CR453CC1*AA	40A	30A	25A	E126105
CR453CD1*AA	50A	35A	25A	E126105
CR453CE2*BB	50A	40A	25A	E126105

UL References

Family	Type	File	Volume	Section	Issued
CR453	A	E1811	17	1	6/15/01
CR454, CR455	A	E1811	17	3	6/15/01
CR453	C	E1811	NA	NA	5/24/01
CR353, CR355	AB	E1811	2	52	09/26/74
CR353, CR355	AC	E1811	2	51	09/25/74
CR353, CR355	AD	E1811	2	21	02/09/67
CR354	AB	E1811	2	50	08/09/75
CR354	AC	E1811	2	50	08/09/75
CR354	AD	E1811	2	50	08/09/75
CR355	EE	E1811	2	26	03/10/70
CR355	EF	E1811	2	25	01/22/70
CR353, CR355	EG	E1811	2	24	10/15/68
CR353, CR355	EH	E1811	2	30	06/01/71
CR353, CR354	FE	E1811	2	54	06/17/75
CR353, CR354	FF	E1811	2	54	06/17/75
CR353	GJ	E1811	2	47	01/31/74
CR353	GK	E1811	3	5	05/26/76

CSA References

Product Line	CSA File Number	CSA Class
CR453C	212530-M-000	1222 01, 4813 01
CR453A		

Auxiliary Contact Ratings

Product Line	Type	Kits	Ratings
CR453A	250 V SPDT	453XC2**	11 A, 1/3 HP at 250 VAC; 1/2 A at 125 VDC; 1/4 A at 250 VDC
CR453A	600 V	453XC6**	A600, Q600 Pilot Duty
CR453A	600 V Interlock	453XM602	A600, Q600 Pilot Duty
CR353A, F	250 V SPDT	353XAAA	10 A, 1/3 HP at 250 VAC; 1/2 A at 125 VDC; 1/4 A at 250 VDC
CR353E	250 V SPDT	353XAAB	10 A, 1/3 HP at 250 VAC; 1/2 A at 125 VDC; 1/4 A at 250 VDC
CR353G	600 V	353XA*C	A600, P300 Pilot Duty



Definite Purpose Controls

Full Voltage Contactors

Section 4

CR453C, CR453A, CR353

Technical Data
25A-150A

AC Coils

Family	Coil Voltage	Inrush VA	Sealed VA	Sealed Watts	Resistance Ohms ±10%	
					Inrush	Sealed
CR453C	24V, 50/60 Hz	29	5.0	2.6	11	
	110-120V, 50/60 Hz	34	6.0	3.3	244	
	208-240V, 50/60 Hz	33	5.6	3.7	990	
CR45*A	277V, 60 Hz	30	6.3	3.2	1520	
	12V, 50/60 Hz	50	7	1.8	2.3	
	24V, 50/60 Hz	50	7	1.8	8.4	
CR355A	110-120V, 50/60 Hz	50	7	1.8	216	
	208-240V, 50/60 Hz	50	7	1.8	852	
	277V, 60 Hz	50	7	2.3	1137	
CR35*F	380-415V, 50 Hz; 440-480V, 50 Hz	50	7	2.3	3322	
	550-600V, 60 Hz	50	7	2.3	4377	
	24V, 50/60 Hz	77	12	4.4	3.9	
CR35*E	110-120V, 50/60 Hz	77	12	4.4	90	
	208-240V, 50/60 Hz	77	12	4.4	366	
	24V, 60 Hz	125	17	8	2.7	
CR35*F	115-120V 60 Hz, 110V 50 Hz	125	17	8	64	
	208-240V 60 Hz, 220V 50 Hz	125	17	8	241	
	277V, 60 Hz	125	17	8	389	
CR35*E	460V 60 Hz, 440V 50 Hz	125	17	8	972	
	600V 60 Hz, 550V 50 Hz	125	17	8	2074	
	24V, 50/60 Hz	233	40	16	1.0	
CR35*E	110-120V, 50/60 Hz	233	40	16	28	
	208-240V, 50/60 Hz	233	40	16	109	
	277V, 60 Hz	233	40	16	169	
CR353G	440-480V 60 Hz, 380-415V 60 Hz	233	40	16	547	
	575-600V 60 Hz, 550V 50 Hz	233	40	16	655	
	115-120V 60 Hz, 110V 50 Hz	1150	80	18.4	2.11	
CR353G	230-240V 60 Hz, 220V 50 Hz	1150	80	18.4	10.6	
	460-480 60 Hz, 440V 50 Hz	1150	80	18.4	41.8	
	575-600 Hz, 550V 50 Hz	1150	80	18.4	67.0	

DC Coils

Family	Voltage DC	Inrush VA	Sealed VA	Sealed Watts	Resistance Ohms ±10%	
					Inrush	Sealed
CR353A	12	46	2.3	2.3	3.13	61.6
	24-28	44	2.0	2.0	13.1	283
	110-125	141	5.1	5.1	102	2783
CR353F	12	107	3.8	3.8	1.35	37.6
	24-28	110	3.8	3.8	5.2	153
	110-125	110	5.25	5.25	133	2519
CR353E	12	278	11.3	11.3	0.54	12.7
	24-48	270	11.1	11.1	2.13	51.9
	48	301	12.6	12.6	7.65	183.0
	110-125	292	12.0	12.0	47.1	1133

Mounting Positions

To maintain operating integrity, contactors must be mounted in one of the positions shown below:

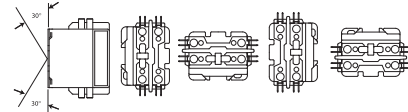

CR453C

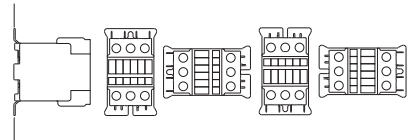

CR453A

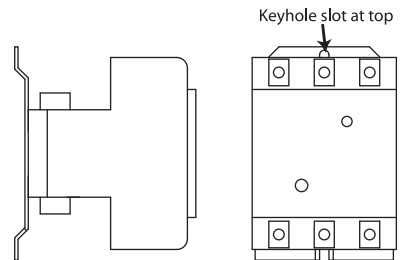

CR353



Definite Purpose Controls

Full Voltage Contactors

CR453C, CR453A

Outlines and Dimensions in./(mm) (For Estimating Only)
20A-150A

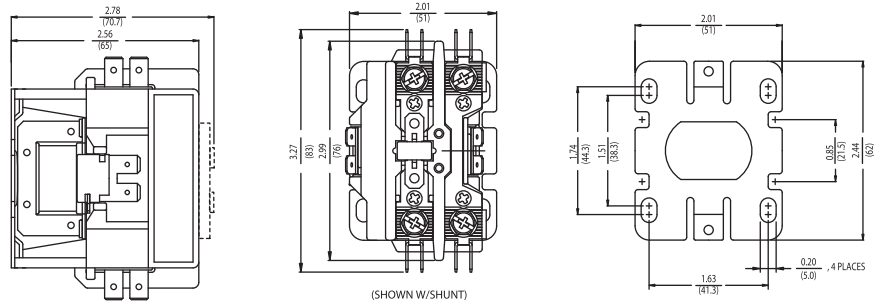

CR453C

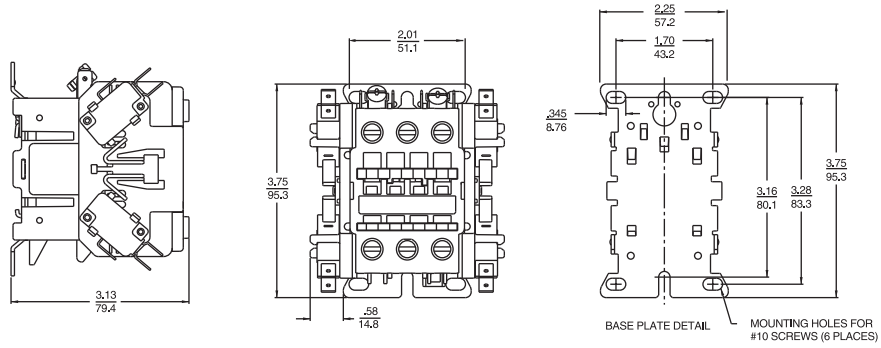

CR453A + 250V Aux. Contacts

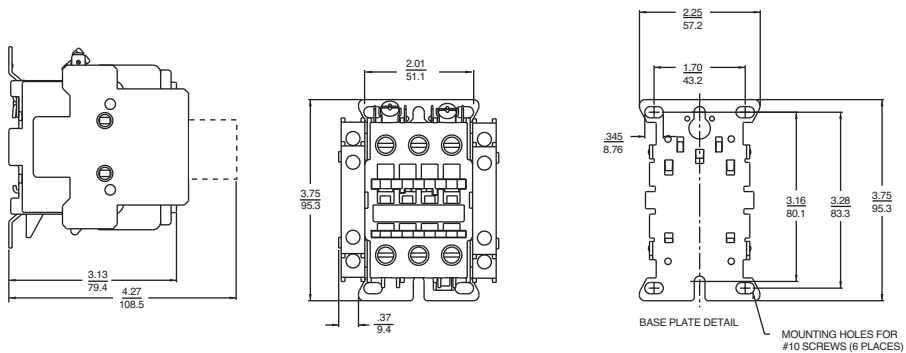

CR453A + 600V Aux. Contacts



Definite Purpose Controls Full Voltage Contactors and Starters

Section 4

CR353

Outlines and Dimensions in./(mm) (For Estimating Only)
25A-150A

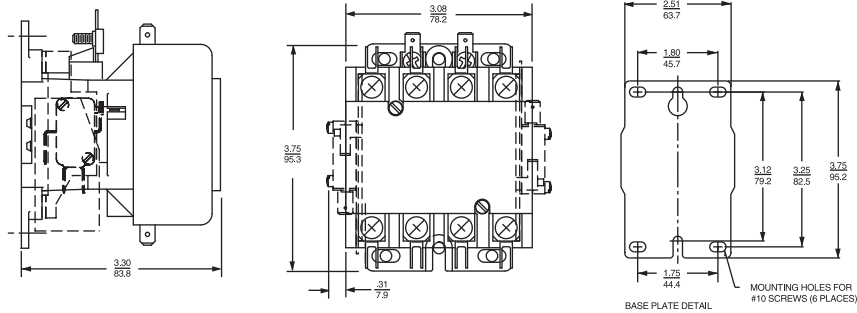

CR353A, 4-pole + 250V Aux. Contacts

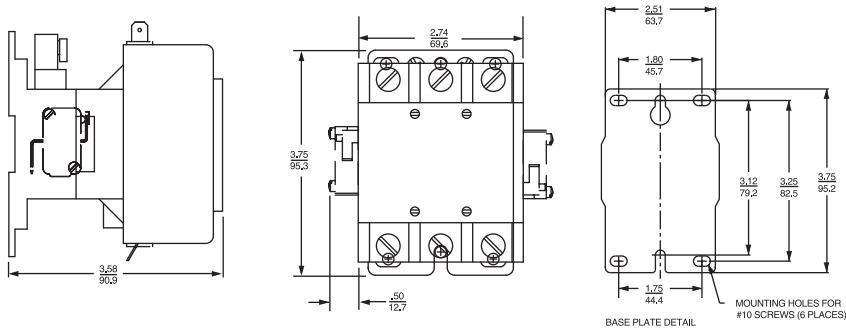

CR353F + 250V Aux. Contacts

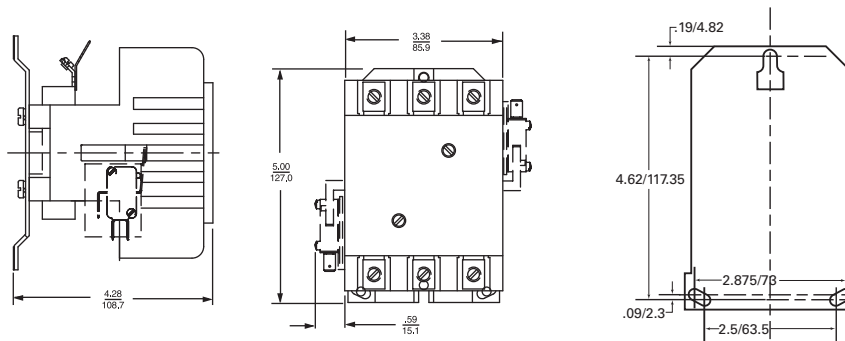

CR353E + 250V Aux. Contacts



Definite Purpose Controls Full Voltage Contactors and Starters

CR453A, CR353

Outlines and Dimensions in./.(mm) (For Estimating Only)
25A-150A

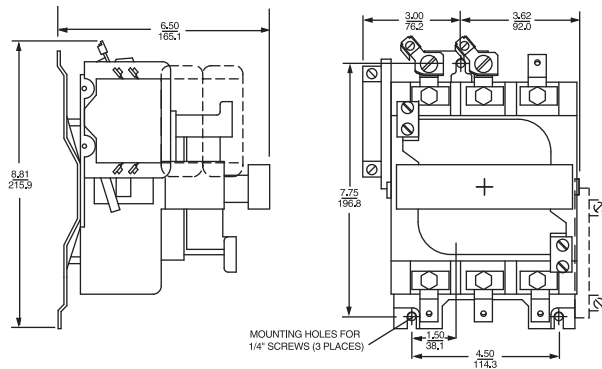

CR353G + 600V Aux. Contacts

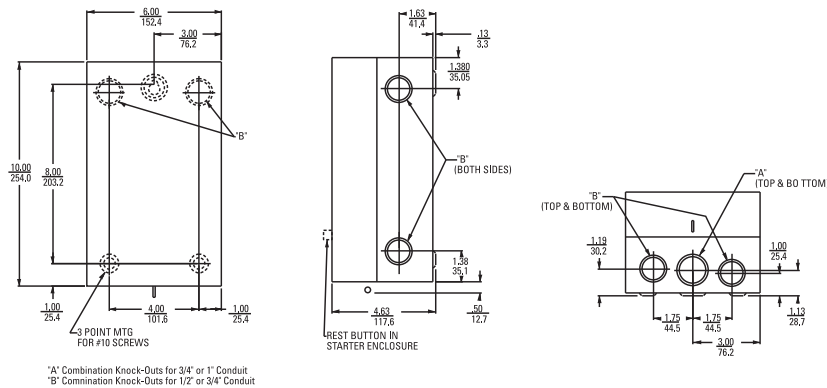

A Combination Knock-Outs for 3/4" or 1" Conduit
B Combination Knock-Outs for 1/2" or 3/4" Conduit

Enclosure CR453XE1A, CR353XE1BB

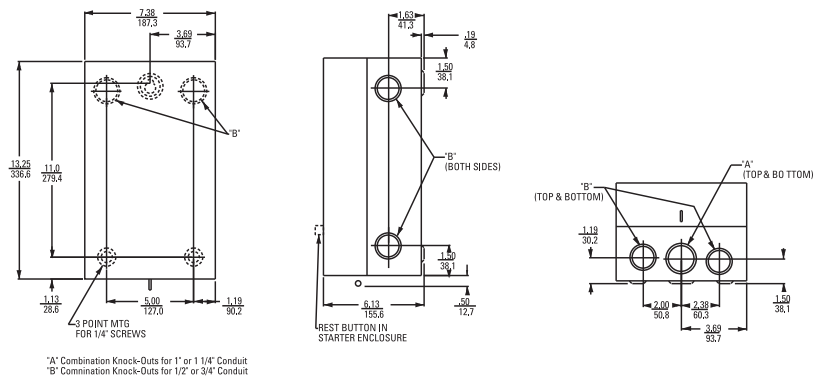

A Combination Knock-Outs for 1" or 1 1/4" Conduit
B Combination Knock-Outs for 1/2" or 3/4" Conduit

Enclosure CR353XE1BC



Definite Purpose Controls

2-Speed Contactors

Section 4

CR455

Outlines, Dimensions in./(mm) and Weights (For Estimating Only)
25A-90A

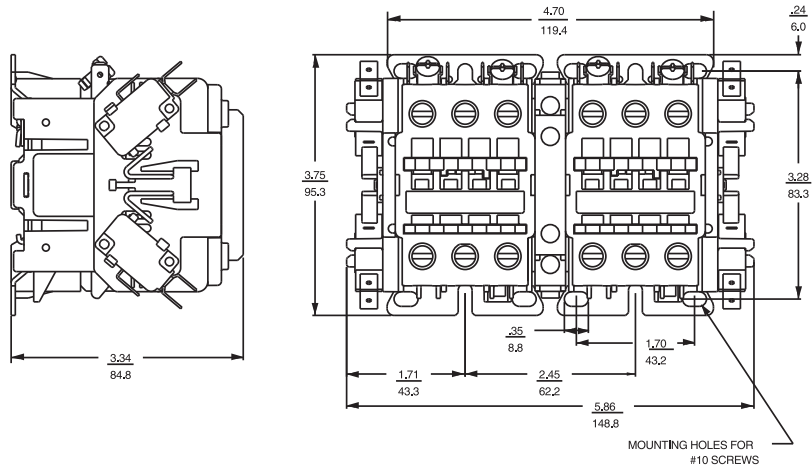

CR455A + 250V Aux. Contacts

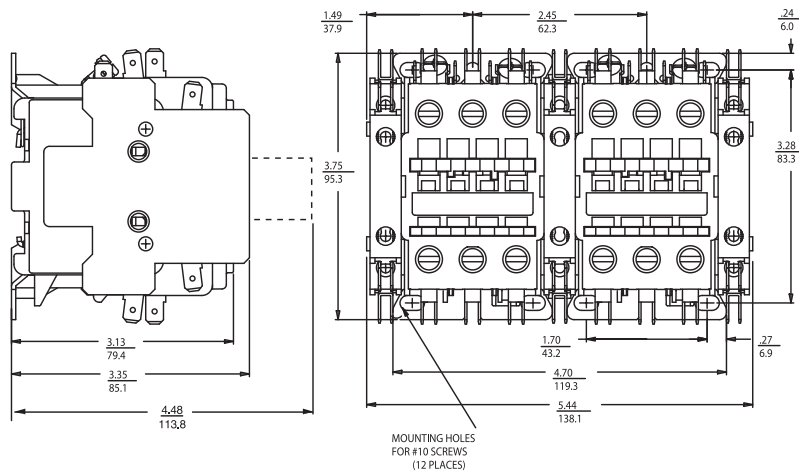

CR455A + 600V Aux. Contacts



Definite Purpose Controls

2-Speed Contactors

CR355

Outlines, Dimensions in./(mm) and Weights (For Estimating Only)
25A-90A

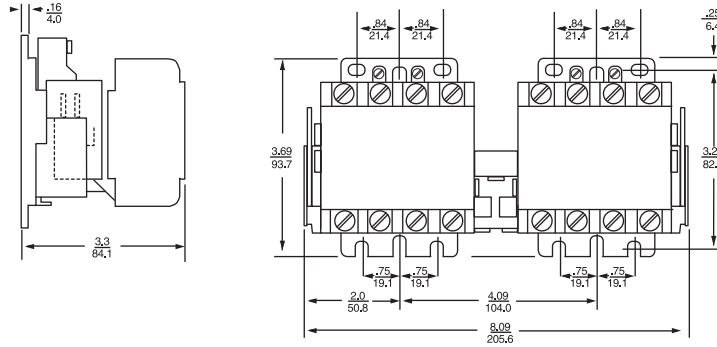

CR355A, 4-4 Pole + 250V Aux. Contacts

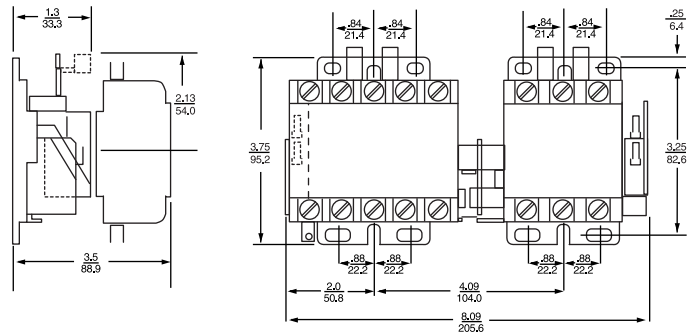

CR355A, 5-3 Pole + 250V Aux. Contacts

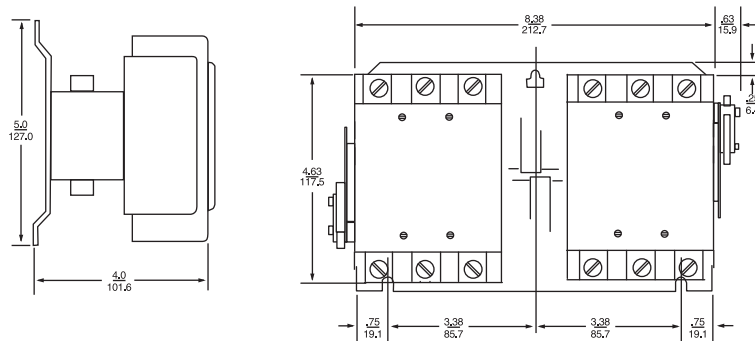

CR355E + 250V Aux. Contacts



Definite Purpose Controls

Full Voltage Starters

Section 4

CR454

Three Phase and Single Phase

Outlines, Dimensions in./(mm) and Weights (For Estimating Only)

25A-60A

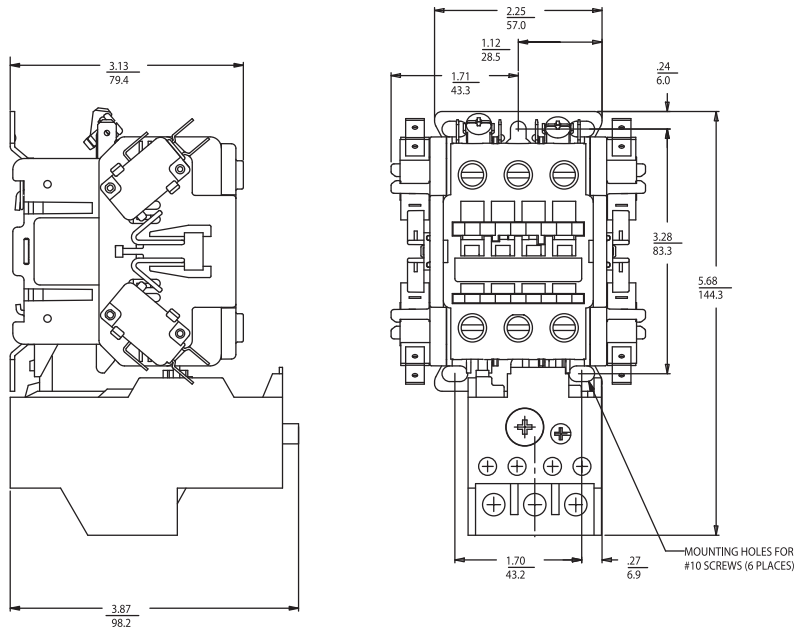

CR454A + 250V Aux. Contacts

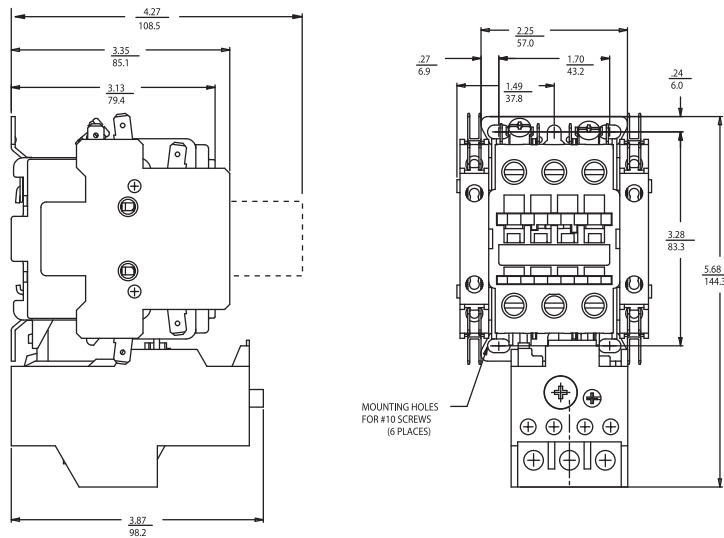

CR454A + 600V Aux. Contacts



Definite Purpose Controls Full Voltage Starters

CR354

Three Phase and Single Phase

Outlines, Dimensions in./(mm) and Weights (For Estimating Only)

25A-60A

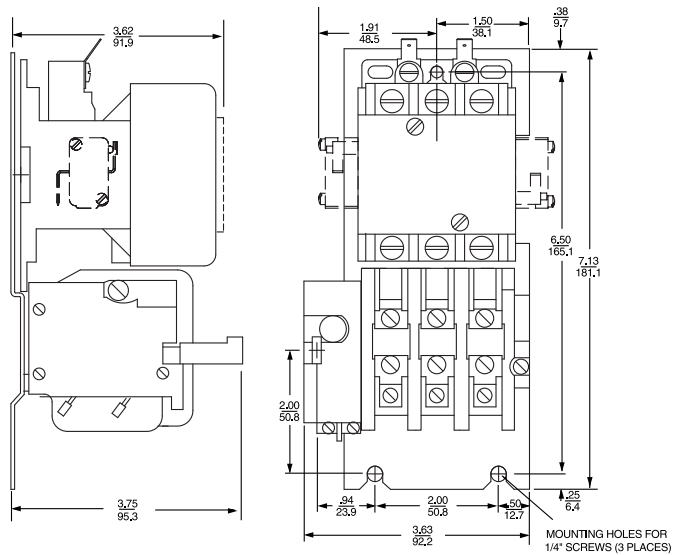

CR354F + 250V Aux. Contacts



Definite Purpose Controls Full Voltage Contactors CR453A, CR453C

Section 4

Bulk Pack Data

CR453C Bulk Pack

Packaging	Description	Units	Item	Weight	Dimensions (H x W x D)
Units in single boxes	Single box	1	1-pole	10.1 oz.	.3" x 2.4" x 3.7"
Units in single boxes	Single box	1	1-pole + shunt	10.4 oz.	.3" x 2.4" x 3.7"
Units in single boxes	Single box	1	2-pole	10.5 oz.	.3" x 2.4" x 3.7"
Units in single boxes	Overpack (20 single boxes)	20	1-pole	2.5 lbs.	7.9 x 8" x 13"
Units in single boxes	Overpack (20 single boxes)	20	1-pole + shunt	2.6 lbs.	7.9 x 8" x 13"
Units in single boxes	Overpack (20 single boxes)	20	2-pole	2.6 lbs.	7.9 x 8" x 13"
Units in single boxes	Case (60 overpacks)	1,200	1-pole	180.8 lbs.	39" x 43.3" x 42.1"
Units in single boxes	Case (60 overpacks)	1,200	1-pole + shunt	185.2 lbs.	39" x 43.3" x 42.1"
Units in single boxes	Case (60 overpacks)	1,200	2-pole	186.8 lbs.	39" x 43.3" x 42.1"
Units in single boxes	20' container (20 cases)	24,000	1-pole	3,616 lbs. (net)	7.8' x 7.7' x 19.4'
Units in single boxes	20' container (20 cases)	24,000	1-pole + shunt	3,704 lbs. (net)	7.8' x 7.7' x 19.4'
Units in single boxes	20' container (20 cases)	24,000	2-pole	3,736 lbs. (net)	7.8' x 7.7' x 19.4'
Units in single boxes	40' container (44 cases)	52,800	1-pole	7,955 lbs. (net)	7.8' x 7.7' x 39.5'
Units in single boxes	40' container (44 cases)	52,800	1-pole + shunt	8,149 lbs. (net)	7.8' x 7.7' x 39.5'
Units in single boxes	40' container (44 cases)	52,800	2-pole	8,219 lbs. (net)	7.8' x 7.7' x 39.5'
Units bulk packed	Overpack (20 DPs)	20	1-pole	12.5 lbs.	3.7" x 11.2" x 14.2"
Units bulk packed	Overpack (20 DPs)	20	1-pole + shunt	12.66 lbs.	3.7" x 11.2" x 14.2"
Units bulk packed	Overpack (20 DPs)	20	2-pole	12.66 lbs.	3.7" x 11.2" x 14.2"
Units bulk packed	Case (90 overpacks)	1,800	1-pole	236.5 lbs.	41.3" x 44.5" x 35.4"
Units bulk packed	Case (90 overpacks)	1,800	1-pole + shunt	243.1 lbs.	41.3" x 44.5" x 35.4"
Units bulk packed	Case (90 overpacks)	1,800	2-pole	245.5 lbs.	41.3" x 44.5" x 35.4"
Units bulk packed	20' container (24 cases)	43,200	1-pole	5,676 lbs. (net)	7.8' x 7.7' x 19.4'
Units bulk packed	20' container (24 cases)	43,200	1-pole + shunt	5,834 lbs. (net)	7.8' x 7.7' x 19.4'
Units bulk packed	20' container (24 cases)	43,200	2-pole	5,652 lbs. (net)	7.8' x 7.7' x 19.4'
Units bulk packed	40' container (52 cases)	93,600	1-pole	12,298 lbs. (net)	7.8' x 7.7' x 39.5'
Units bulk packed	40' container (52 cases)	93,600	1-pole + shunt	12,641 lbs. (net)	7.8' x 7.7' x 39.5'
Units bulk packed	40' container (52 cases)	93,600	2-pole	12,766 lbs. (net)	7.8' x 7.7' x 39.5'

CR453A Bulk Pack

Single pack

Product	Min. order/additional multiples	Weight per box	Dimensions per box (H x W x D)
Contactors with no aux. contacts	96/24	1 lb.	3.5" x 2.5" x 4.25"
Contactors with 1 aux. contacts	108/18	1.1 lbs.	3.5" x 3" x 4.25"
Contactors with 2 aux. contacts	90/15	1.2 lbs.	3.5" x 3.5" x 4.25"
Starters	48/24	3.1 lbs.	7.25" x 5.75" x 8"
2-speed controllers	48/24	3.1 lbs.	7.25" x 5.75" x 8"

Corrugated box Bulk Pack

Product	Min. order/additional multiples	Items per tray	Trays per box	Weight per box	Dimensions per box (H x W x D)
Contactors with no aux. contacts	96/32	8	4	30 lbs.	7.5" x 19" x 19"
Contactors with 1 aux. contacts	96/32	8	4	30 lbs.	7.5" x 19" x 19"
Contactors with 2 aux. contacts	96/32	8	4	30 lbs.	7.5" x 19" x 19"
Starters	48/24	6	4	74 lbs.	14.25" x 23.5" x 25"
2-speed controllers	48/24	6	4	74 lbs.	14.25" x 23.5" x 25"

Skid pack

Product	Min. order/additional multiples	Items per tray	Trays per layer	Layers per skid	Weight per layer	Dimensions per layer (H x W x D)
Contactors with no aux. contacts	240/80	8	10	3 to 8	45 lbs.	4" x 40" x 48"
Contactors with 1 aux. contacts	240/80	8	10	3 to 8	50 lbs.	4" x 40" x 48"
Contactors with 2 aux. contacts	240/80	8	10	3 to 8	55 lbs.	4" x 40" x 48"
Starters	120/40	4	10	3 to 8	55 lbs.	4" x 40" x 48"
2-speed controllers	120/40	4	10	3 to 8	50 lbs.	4" x 40" x 48"

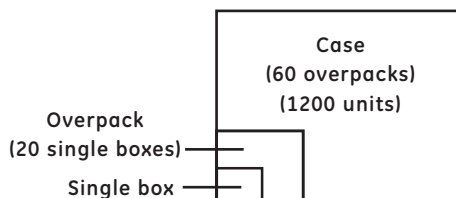

Bulk Pack — Individual Boxes

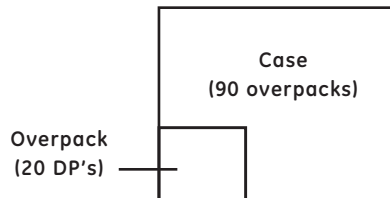

Skid Pack — Not Individually Boxed

